

# User's Manual BV9562I

**IN-DASH MOTORIZED DOUBLE-DIN  
MULTIMEDIA PLAYER (MP3/CD) AM/FM RECEIVER  
WITH 7" WIDESCREEN  
TOUCH SCREEN TFT MONITOR  
WITH FULL iPod® CONTROL  
WITH USB AND SD MEMORY CARD PORTS  
AND AV INPUT**

**RDS COMPATIBLE MODEL**



## BV9562I

**IN-DASH MOTORIZED DOUBLE-DIN  
MULTIMEDIA PLAYER (MP3/CD) AM/FM RECEIVER  
WITH 7" WIDESCREEN TOUCH SCREEN TFT MONITOR  
WITH FULL iPod® CONTROL  
WITH USB AND SD MEMORY CARD PORTS  
AND AV INPUT**

**RDS COMPATIBLE MODEL**  
01.2010

BOSS Audio Systems is not affiliated with Apple, Inc.



iPod is a trademark of Apple, Inc., registered  
in the U.S. and other countries.

**tech support: [www.bossaudio.com/support](http://www.bossaudio.com/support)**

# BOSS®

**AUDIO SYSTEMS**

BOSS Audio Systems • 3451 Lunar Court • Oxnard, CA 93030

[www.bossaudio.com](http://www.bossaudio.com)

**800.999.1236**

# BOSS®

**AUDIO SYSTEMS**

BOSS Audio Systems is not affiliated with Apple, Inc.

# Contents

*Thank you for buying this product.*

Please read through these operation instruments so you will know how to operate your model properly. *After reading please keep this booklet in safe place for future reference.*

## 1 Before You Start

- Important Safeguards 4
- About this manual 4
- Precautions 5
- Maintenance 6
- Location & function of the controls 7
- Remote control 8
- Specifications 11

## 2 Installation

- Wiring Connections 12
- Installing the Unit 13
- Detach the Unit 14

## 3 Common Operations

- To Select Source by Menu 15
- Reset the Unit 15
- Turning the Unit On/Off 15
- Volume Control 15
- Setting the Sound Characteristics 15
- EQ Setting 15
- Turning Loudness On/Off 16
- Eject a Disc 16
- Insert a SD Card 16
- Angle Setting 16
- Mute Function 16
- Night Mode 16
- Mode Selector 16
- Infrared Sensor 16

## 4 Main Menu

- Main Menu Setup 17
- Video Setup 17
- Audio Setup 18
- Source Setup 18
- System Adjustment 18

## 5 DISC/VCD/MP4

- DISC/VCD/MP4 Setup 22
- DISC/VCD/MP4 Operation 22
- Selecting Tracks 22
- Number Buttons 22
- Pause the Playback 22
- Stop the Playback 22
- Play tracks at Random 23
- Repeat Playing 23
- Skip backward/forward/FF/FREW the Playback 23
- System Switch 23
- Slow Motion Playback 23
- Increase Picture Size 23
- On Screen Display 23
- Setting the Playback Time 24
- Changing Audio Language 24
- Changing the Subtitle Language 24
- Changing the Viewing Angle 25
- Selecting Audio Output 25
- Program Playing 25
- Playing PBC(Menu) 25
- Selecting Menu 26
- DISC Setup Menu 26

## 6 CD/MP3/SD/USB

- CD/MP3/SD/USB Setup 33
- CD/MP3/SD/USB Operation 33
- Selecting Tracks 34
- Repeat Playing 34
- Number Buttons 34
- Selecting Track 34
- Stop Play 34
- Playing Tracks at Random 34
- Pause the Playback 35
- Skip backward/forward/FF/FREW the Playback 35

Common Symptoms	Cause	Solution
There is no power.	The car ignition is switched off	If the power supply is properly connected to the car accessory, switch the ignition key to ON or ACC.
	The fuse has blown.	Replace with same amperatge fuse rate.
The disc cannot be loaded.	There is another disc inside the player	Remove the disc from the player
The device does not work correctly (EJECT, LOAD, PLAY)	Inserted disc is upside down	Insert the compact disc with the label facing upward
	The surface of disc is extremely dirty, Scrached or damaged.	Clean the disc or try another disc, if the new disc works correctly, the first disc is damaged.
	Temperature inside the car is too high.	Cool off until the ambient temperature returns to normal.
There is no sound.	The volume control is set too low.	Turn up the volume properly.
	The device has not been wired correctly.	Check the connections according to the wiring diagram.
The operation keys do not work	1. The built-in microprocessor is not operating properly. 2. Front panel is not properly attached into its place	1. Switch the device off and on again or press the RESET button. 2. Remove and reinstall the front panel.
The sound of the disc player skips	The installation angle is more than 30 degrees	Adjust the installation angle to less than 30 degrees
	The surface of the road is uneven.	Wait until the road becomes smoother before playing the disc.
	The surface of disc is extremely dirty, scrached or damaged.	Clean the disc or try another disc, if the new disc works correctly, the first disc is damaged.
No radio reception.	The antenna cable is not connected.	Insert the antenna cable firmly into the antenna socket of the unit.
In automatic search mode the radio does not stop at a transmitting station.	The transmission signals are too weak.	Tune in to a radio station manually.

*On Screen Display* 35

*Program Playing* 35

*Eject SD Card* 35

*Eject USB* 35

## 7 Tuner

*Listening to the Radio* 36

*Band Selector* 36

*Manual/Automatic Tuning* 36

*DX/LOC Selector* 36

*Selecting The stored Station* 36

*MO/ST Selector* 37

*AMS* 37

*Number Buttons* 37

*On Screen Display* 37

*Goto FREQ* 37

*RDS Setup* 38

*Alternative Frequencies* 38

*Traffic Alarm* 38

*Program Type* 38

## 8 AUX

*AUX Touch Screen Menu* 39

## 9 IPOD

*IPOD Operation* 40

*Selecting Tracks Fast* 40

*Playing Track FF/REW* 40

*Switch* 40

*Repeat Playing* 40

*Playing Tracks at Random* 40

*Pause the Playback* 40

*File Selector* 41

*Video or Picture Mode* 41

*Eject IPOD* 41

## 10 Additional Information

*Simple Troubleshooting Guide* 42

## IMPORTANT SAFEGUARDS About this manual

- 1 **Be sure to connect the color coded wires according to the diagram. Incorrect connections may cause the unit to malfunction or damage the vehicle's electrical system.**
- 2 **Be sure to connect the speaker (-) wires to the speaker (-) terminal. Never connect the left and right channel speaker cables each other or to the vehicle body.**
- 3 **Make sure all the connections are completely correct before turning on your unit.**
- 4 **When replacing the fuse(s), the replacement must be of the same amperage as shown on the fuse holder.**
- 5 **Do not block vents or radiator panels. Blocking them will cause heat to build up inside and may result in fire.**
- 6 **To lessen the driver's distraction, install the unit in an appropriate place.**
- 7 **Power the unit on after starting the engine otherwise it will shut off due to lack of power.**
- 8 **Do not place the remote control in a place susceptible to high temperature or direct sunlight. Doing so will damage the remote.**
- 9 **Do not use the unit in extremely high or low temperatures. Also avoid high humidity and direct sunlight.**
- 10 **Take care of the magnetism of the unit. Do not put the credit card, cassette or watch around the unit.**
- 11 **To minimize disturbance of the video frequency, keep far away from the unit when using your phone.**

This unit features a number of sophisticated functions ensuring superior operation. All the functions have been designed for the easiest possible use, but many are not self-explanatory. This manual will help you understand the functions and operations of the unit. DISC/VCD/CD/MP3/MP4/SD operation that can only be operated by the remote control, but there are also functions that can be operated by the buttons provided for the main unit.

### WARNING!

**Do not watch or operate the video monitor while driving.** Doing so is unsafe and can distract the driver, which may cause an accident.

In some states or countries it is illegal for a driver to operate or view a video monitor while driving. It may also be illegal for a passenger to operate or view a video monitor in a moving vehicle even if the driver is not watching it.

Be sure that the installation and operation of this product is in compliance with local rules and regulations.

## File Selector

During IPOD mode, press **MENU** in the monitor to go back to the previous catalog.

Press **⬆** in the monitor to select the previous 5 tracks, press **⬇** to select the next 5 tracks (show as in the right of the picture).

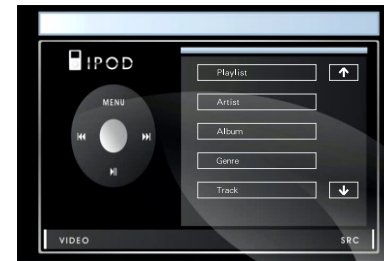

### Note:

- \* This function is operated by using the touch screen only.

## Video or Picture Mode

During IPOD mode, press **VIDEO** to select video or audio. Video and picture can be played at this time.

The unit and the remote control can not be operated in this mode, you can just operate IPOD to select video and picture.

### Note:

- \* This function is operated by using the touch screen only.
- \* The IPOD TV should be set ON in this function.
- \* Video playback requires Gen 5.5 or earlier Photo or Video iPod, iPod Touch, iPod Classic, and iPod Nano with video will only play music files.

## Eject IPOD

If the iPod is removed during iPod mode, the unit will automatically switch to radio mode.

## IPOD Operation

During IPOD playback, connect the IPOD wire (5V) to the one in backside of the main unit. When the iPod is loaded, the unit will play a track. To go back to the source status, press iPod to enter into iPod setup:

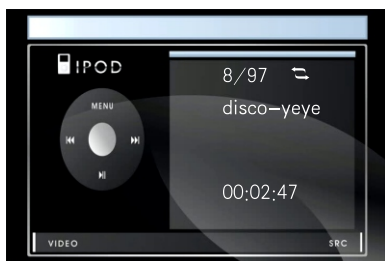

**MENU** Back to the previous menu

**⏮** Briefly press to play previous track, press and hold to fast forward.

**⏭** Briefly press to play next track, press and hold to fast rewind.

**⏸** Play/ pause

**VIDEO** Mode switch between IPOD and main unit

**SRC** Mode switch

## Selecting Tracks

During IPOD playback, press **⏮** to return to the beginning of the current track, press **⏮** again within 3 seconds to play previous track, press **⏭** to play next track.

### Note:

\* Pressing **⏮** / **⏭** in the monitor to performs the same function

## Playing Track F.F/F.REW

Press and hold **⏭** or **⏮** to play the track fast forward or fast rewind. Do it again or press ENTER to resume to play normally.

### Note:

\* Pressing and holding **⏮** / **⏭** in the monitor also performs the same function

## Switch

During playback, press **VIDEO** to turn to IPOD, the screen shows: *Play video on your iPod. Then touch screen to return.* Then you can operate your iPod. Press **VIDEO** again to return to main unit operation.

### Note:

\* This function is operated by using the touch screen only.

## Repeat Playing

During playback, press **RPT** to track repeat, disc repeat, off. Press it again to cancel this function.

### Note:

\* This function is operated by using the remote control only.

## Playing Tracks at Random

During IPOD playback, when pressing **RDM** button, *Shuffle off, Shuffle Track, Shuffle Album* will be activated.

### Note:

\* This function is operated by using the remote control only.

## Pause the Playback

During IPOD mode, press **⏸** button to pause the playback, Press it again to return to normal playback.

### Note:

\* Press **SEARCH+/-** in the monitor or briefly press **SEARCH+/-** on the head unit also performs the same function.

## PRECAUTIONS

This unit can play the following DISCs only:

Type of disc	Recorded material	Size of disc
DISC	Sound and moving pictures	12cm
VCD	Sound and moving pictures	12cm
CD	Sound only	12cm
MP3	Sound only	12cm
MPEG-4	Sound and moving pictures	12cm

**NOTE:** The unit is compatible with VCD1.0/2.0/3.0 version and DVCD disc.

- **When driving, do not attempt to modify the unit. Modifying the unit may cause an accident.**
- **Stop the vehicle before carrying out any operation that could interfere with your driving.**
- **Do not turn the unit on in extremely high or low temperature. Be sure the temperature inside the vehicle is between +60° C and -10° C before turning on your unit.**
- **To enjoy optimum sound and images while playing, handle the DISCs as follows:**

—Do not use your discs with paste residue or ink attached.



—Do not use discs with labels or stickers attached, which may leave a sticky residue while beginning to peel off. (Shown as the picture)

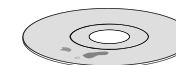

—Clean the discs with an optional cleaning cloth. Wipe from the center out. (Shown as the picture)

—Handle the DISC by its edge to keep the DISC clean, and do not touch the surface.



## Maintenance

### Replacing the Fuse

Make sure the amperage matches the specified value when replacing the fuses. If the fuse is blown, replace it with a new one. Be sure you are using one with the correct rating. If the same problem occurs, it would be subjected to the malfunction. In such cases, please consult to the nearest service dealer.

#### ⚠ Warning

Never use the fuse with the rated amperage more than that supplied to your unit, otherwise it will damage the unit.

### Replacing the Remote Battery

When the range of the operation of the remote control becomes short or stops operating, Replace the battery. Be sure to use a lithium Battery button Cell Cr2025.

Gently pull out the Battery Holder while pressing the Stopper.

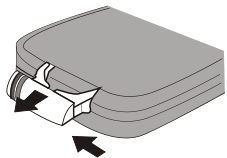

Put the button-type battery with mark(+) upward into the Battery Holder.

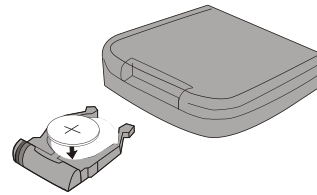

Insert the Battery Holder into the Remote Control.

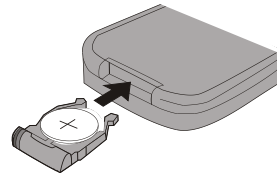

### Precautions on Using Lithium Battery

Always keep the lithium battery beyond children's reach. In case swallowed, see a doctor immediately.

Cleaning the battery with a dry cloth, to ensure its perfect connected.

Install the battery with the proper polarity.

To prevent short circuit, do not use metal tweezers to handle the battery.

#### ⚠ Warning!

Improper handle with the battery may lead to explosion. It cannot be charged, disassembled or thrown into a fire.

### AUX Touch Screen Menu

Press SRC to switch to the AUX mode:



In AUX mode, select AV SET:

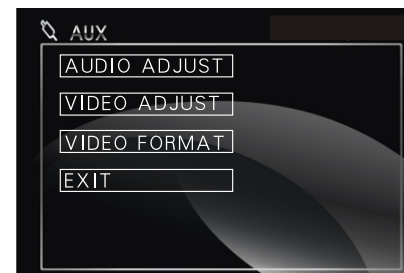

AV SET

For more details to adjust AUDIO, VIDEO and SYSTEM (Auto 1: PAL, NTSC, SECAM), (Auto 2: P-M, P-N). Please refer to pages 19 to 20.

VOL- To decrease the volume

VOL+ To increase the volume

Mode selector

## RDS Setup

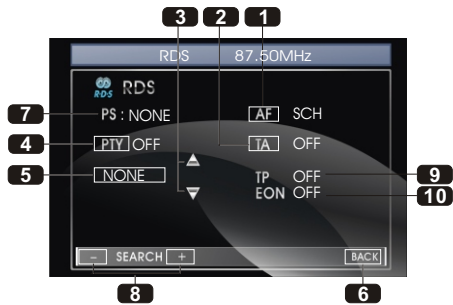

- 1 AF(Alternative Frequencies)**  
Press it to activate AF function.
- 2 TA (Traffic Alarm)**  
Press it to activate TA function.
- 3 ▲/▼**  
Press it to select PTY code.
- 4 PTY(Program Type)**  
Press it to activate PTY function.
- 5** During PTY ON, press this button to search the playing track's type.
- 6 BACK**  
Press it to turn to return to the radio.
- 7 PS:**  
To display the current RDS station's programs information.
- 8 SEEK+/-**  
Press it to tune automatically.
- 9 TP(Traffic Program)**  
TP OFF: the current station doesn't have any traffic programs;  
TP Search: Search for stations with traffic programs;  
TP ON: the current station is broadcasting traffic program.
- 10 EON(Enhanced Other Networks information)**  
EON OFF: No station has TP;  
EON ON: RDS signal finds that another station is broadcasting traffic program and reminds the user of searching this station.

## Alternative Frequencies

Briefly press **2** AF to activate the auto searching station function. When AF is on, the unit will skip to the RDS Frequency with good signal.

- Note:**
- \* It is also performed by pressing **1** in the monitor.

## Traffic Alarm

Briefly press **2** TA to activate the traffic alarm function. When AF is on, there is TA displayed on the LCD. If there is no TP, the mode will search TP stations automatically. The TA is green when it is played by a station, if not, it is yellow. When TA is playing, the volume will be adjusted to a TA level automatically. When in other modes (such as DISC, AUX), if a TA program is played, the mode will skip to the RDS status automatically. It will resume to the primary mode after the TA is over.

- Note:**
- \* It is also performed by pressing **2** in the monitor.
  - \* When TA is off, the LCD will not display TA.

## Program Type

Briefly pressing **7** PTY to activate PTY function. When PTY is on, **PTY ON** appears in the monitor. You can press **UP/DOWN** to select the program type, and then press **PTY CODE** to search the special program. The monitor displays **PTY SEARCH**.

If PTY is off, **PTY OFF** appears in the monitor and the searching is disabled.

- Note:**
- \* It is also performed by pressing **4** in the monitor.

# Before You Start

## Location of the Controls

Front Panel

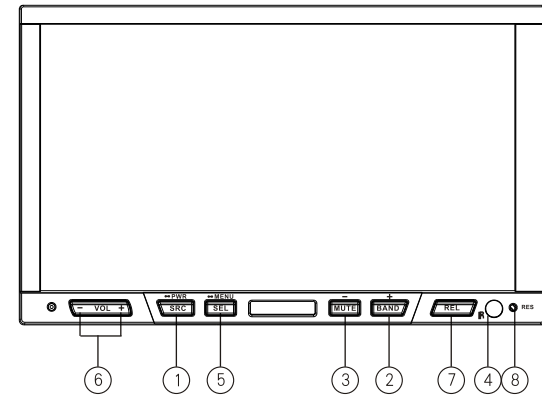

The Base

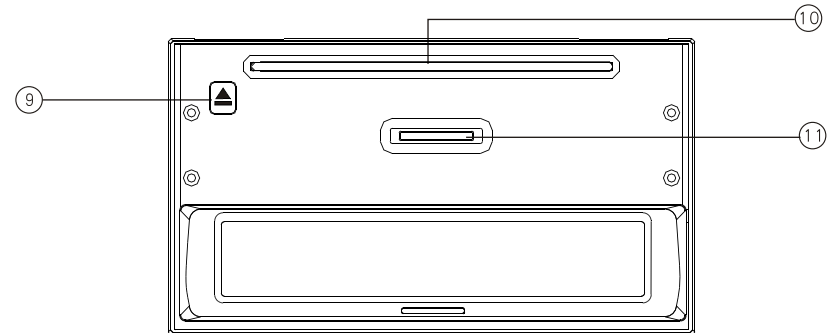

# Before You Start

- ① SRC/PWR  
During waiting mode, briefly press it to turn on the unit; during working status, briefly press it to select radio mode or playback mode/press and hold it to turn the unit on or off.
- ② BAND / + (Bands selector / Increase) Button  
During radio mode, press it to select bands, press and hold REL until *ANGLE* appears to adjust angle backward.
- ③ MUTE / - ( Mute / Decrease ) Button  
Briefly press it to mute; press and hold it to switch to the night mode; press and hold REL until *ANGLE* appears to adjust angle forward.
- ④ REMOTE Infrared Sensor
- ⑤ SEL/MENU Button  
Briefly press it to select the function; press and hold it to display the main menu.
- ⑥ VOL + / VOL -  
Press VOL + / VOL - to increase or decrease the volume, and pressing them will also be used to adjust Balance, Fade, Bass and Treble.
- ⑦ REL Button  
Briefly press it to slidedown the monitor, then you can insert or eject a disc or a SD card. If you press and hold, the monitor shows *ANGLE*. Then press +/- to adjust angle.
- ⑧ RES Button  
Press it to set the unit to initial status.
- ⑨ ▲ (Eject) Button  
Press it to eject a disc.
- ⑩ Disc Loading Slot  
Press REL first before you load the disc.
- ⑪ Common SD Card Slot

# Tuner

## MO/ST Selector

During radio status, you can press ⑥ **ST** button on the remote control to select **MO-NO** mode or **STEREO** mode.

Stereo reception is on when “Stereo” appears.

It is switched to MONO mode when “Mono” appears.

### ▣ Note:

- \* It is only valid on remote control.
- \* Switch to MONO compulsively to improve the listening quality when weak signal.
- \* It is only valid in FM.

## AMS

During radio status, briefly press ④ AMS button on the remote control to scan each stored station 6 seconds respectively which are stored in ⑫ Number Buttons (from 1 to 6). When you can press the corresponding Number Buttons or AMS button when your desired station is on, it will stop on that station.

When you press and hold ④ AMS button for more than 2 seconds, it will automatically activate the memory storing function. The radio automatically selects a station and has it stored in any one of the ⑫ Number Buttons (from 1 to 6).

### ▣ Note:

- \* The unit can store up to 6 stations for each band.
- \* Pressing ⑦ in the monitor also performs the same function.

## Number Buttons

During radio status, press **Number Buttons** to receive the stored stations.

During radio status, **Number Buttons (from 1 to 6)** ⑫ can help you store your favorite station. You can follow the steps as below:

- 1 When turned to a station, press and hold any one of the **Number Buttons (from 1 to 6)** until the number appears on the LCD, which indicates that station is already stored in the corresponding number button.
- 2 Press and hold another number button more than 2 seconds when listening in a station in one number button's, the station will be stored in that number button.

### ▣ Note:

- \* Pressing ⑬ in the monitor performs the same function.

## On Screen Display

During radio status, briefly press ⑧ OSD to display the edition information. The preset frequency displays as the default setting.

## Goto FREQ

Press ② GOTO, and the monitor shows FREQ. Then press the number to input the valid frequency as 100.00. The program will then be played.

### ▣ Note:

- \* It is only valid on remote control.
- \* It is only valid when GOTO FREQ is ON in main menu.



## Listening to the radio

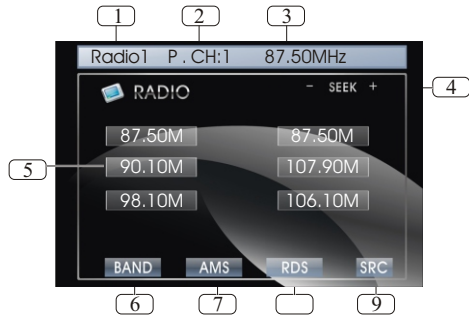

- 1 **Band Indicator**  
Shows which band the radio is tuned to.
- 2 **Preset Number Indicator**  
Shows what preset has been selected.
- 3 **Frequency Indicator**  
Shows which frequency the tuner is tuned.
- 4 **SEEK+ / SEEK-**  
Briefly press to tune by the presettable range, press and hold to tune automatically.
- 5 **The 6 stations of the current band.**  
Briefly press to select station, hold and press to save the current station to one of the 6 stations.
- 6 **BAND(AM/FM)**  
To select the bands.
- 7 **AMS**  
Briefly press to scan the current station, hold and press to search the stored station automatically.
- 8 **RDS**  
Press it to enter the RDS MENU.
- 9 **SRC**  
Press this button to select the signal source.

## Band Selector

During radio status, repeatedly press 3 BAND button to select bands in the following order:



- **Note:**  
\* Pressing 2 in the monitor or BAND on the main unit also performs the same function.

## Manual/Automatic Tuning

**Manual Tuning:** Press 20 (▶▶ or ◀◀) button on the remote control continuously to select a station downward or upward respectively.

**Automatic Tuning:** Press and hold 20 (▶▶ or ◀◀) button for more than 3 seconds, the radio automatically searches a station downward or upward respectively and plays when it finds a station.

- **Note:**  
\* Pressing 4 in the monitor performs the same function.

## DX/LOC Selector

During radio status, press 5 LOC button to select strong or weak station reception. "LOC" appears on the display and only local station is available. when it disappears both distance and local stations can be received.

- **Note:**  
\* The function is only valid on remote control.  
\* The function is invalid in AM band.

## Selecting the Stored Station

During radio status, press 27 ▲ button to select the stored station upward, press ▼ to select the stored station downward.

- **Note:**  
\* The function is only valid on remote control.

## Remote Control

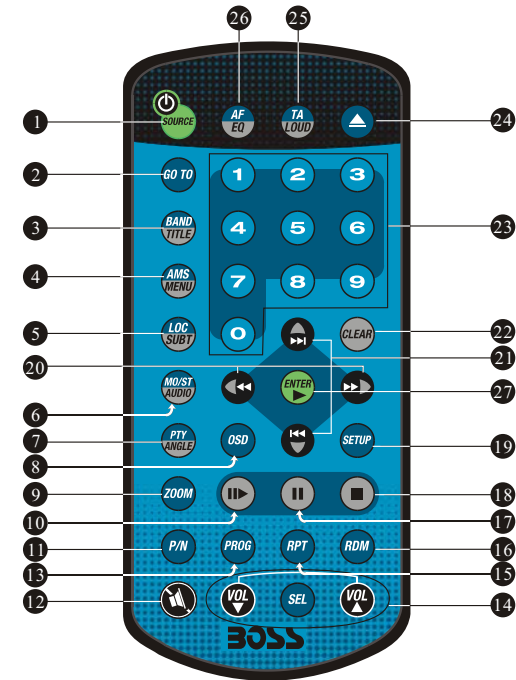

Tips:  
For more information on replacing battery, please refer to **Replacing the Battery** on page 6.

# Before You Start

- 1 SOURCE/PWR
- 2 GOTO (playing time/track)
- 3 BAND/TITLE
- 4 AMS/MENU
- 5 LOC/SUB -T
- 6 ST/AUDIO
- 7 PTY/ANGLE(Program type/DVD play angle)
- 8 OSD  
During DISC mode, briefly press it to show the current information, press and hold it to turn off. During radio mode, press this button to show the version number.
- 9 ZOOM (zoom in or zoom out)
- 10 **II▶** (Slow Forward/Rewind)
- 11 P/N (System Adjusting)
- 12 **⊗** Mute
- 13 PROG(Program playing)
- 14 VOL+/VOL-/SEL
- 15 RPT(Repeat Playing)
- 16 RDM (Playing Tracks at Random)
- 17 **II** (Pause/Play)
- 18 **■** (Stop Playing)
- 19 SETUP
- 20 **◀▶** (F.R/F.F)
- 21 **◀▶** (Previous/Next Track)
- 22 CLEAR
- 23 0~9( Number) Buttons
- 24 **▲** (Eject Button)
- 25 TA/LOUD(traffic alarm/loudness)
- 26 AF/EQ(Automatic frequency conversion/equalizer)
- 27 **◀▶/▲/▼**/ENTER (Left/Right/Up/Down ENTER)

# CD/MP3/SD/USB

## Pause the Playback

During CD/MP3/SD/USB playback, Press **17 II** to switch between play and pause.

**Note:**

- \* Pressing **17** in the monitor also performs the same function.

## Skip backward/forward/F.F /F.REW the playback

Press **20 (◀ or ▶)** on remote control to perform fast rewind or fast forward.

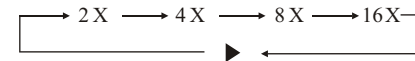

**Note:**

- \* This function is operated by using the remote control.

## On Screen Display

During CD status, press **OSD** button the display shows:

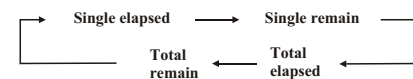

**Note:**

- \* This function is operated by using the remote control.

## Program Playing

During CD mode, press **15 PROG**, the TFT displays the program menu. Press **NUMBER BUTTONS** to select the track Number and then press **27** to move the cursor to **START**. Press **ENTER** to start program playing. Move the cursor to EXIT and press ENTER to exit the program playing. Move the cursor to **◀◀** and press ENTER to the previous page; move the cursor to **▶▶** and press ENTER to the next page. During this process, press **18 ■** to cancel the program playing.

**Note:**

- \* The function is only valid on remote control.
- \* Press **22 CLEAR** to clear the mistake input.

## Eject SD Card

Push SD card to eject it. During SD Mode, ejecting the SD card will switch the unit to DISC mode. If there is no disc, the unit will switch to USB Mode. If no USB, the unit will switch to Radio mode.

## Eject USB

Pull out the USB to eject it. During USB Mode, removing the USB will switch the unit to Disc. If there is no DISC, it will switch to Radio mode.

## Selecting Tracks

During MP3/SD/USB playback, press **21** **⏮** to play previous track, press **21** **⏭** to play next track.

During CD playback, first press **21** **⏮** to return to the beginning of the current track, press **21** **⏮** again within 3 seconds to play previous track, press **21** **⏭** to play next track.

### Note:

- \* Pressing **⏮** and **⏭** on the monitor perform the same function.
- \* In CD/MP3/SD/USB mode, you can press track's Number or name to play.

## Repeat Playing

During CD/MP3/SD/USB playback, press **15** **RPT** to replay the current track, press it again to cancel this function.

### Note:

- \* This function is operated by using the remote control.
- \* The default setting is Disc Repeat.

## Number Buttons

Press one of **23** **Number Buttons(0~9)** to select a track to play automatically.

### Note:

- \* Press track region and the screen shows the number keys, touch the number to select tracks.
- \* Press **22** **CLEAR** to clear the mistake input.

## Selecting Track

During CD playback, first press **2** **GOTO**, and TFT shows : **DISC go to:--:--**.press your desired time of the playback by using number buttons.

Then press GOTO button, **track go to:--:--** appears on TFT, now input your desired numbers to play the current time of your selection.

During MP3/SD/USB mode, first press **2** **GOTO** and the TFT shows:--:. Then press NUMBER BUTTONS to input the MP3/SD track's Number to play it; then press **GOTO** button, and the TFT shows : --:--, now input the desired time to play the current track at this point.

### Note:

- \* This function is operated by using the remote control.
- \* Press **22** **CLEAR** to clear the mistake input.

## Stop Play

During CD/MP3/SD/USB playback, Press **18** **■** to stop the playback.

### Note:

- \* Pressing **■** in the monitor performs the same function.

## Playing Tracks at Random

During CD/MP3/SD/USB playback, press **16** **RDM** button on the remote control to play any track at random under the directory which you select. Press it again to return to normal playing.

### Note:

- \* This function is operated by using the remote control.

## Specifications

### General

Power Requirement	14.4V DC (11-16V allowable)
Load Impedance	4Ω
Max.Power Output	85W X 4
Tone Controls	±7dB Bass 100Hz Treble 10KHz
Dimensions	Approx.184 x 178 x 100 mm (d/w/h)
Mounting Dimensions	Approx.164 x 183 x 112 mm (d/w/h)
Weight	Approx.3.5kg

### FM Section

Tuning Range (Optional)	87.5-108(MHz) (Europe) 87.5-107.9(MHz) (U.S.A.)
IF Range	10.7MHz
Usable Sensitivity (-30dB)	10dBuV
Signal-to-noise Ratio	60dB
Stereo Separation	30dB (1KHz)
Frequency Response	40-12KHz

### AM Tuner Section

Frequency Range (Optional)	522-1620(KHz) (Europe) 530-1710(KHz) (U.S.A.)
IF Range	450KHz
Usable Sensitivity (-20dB)	32dBuV

### VCD/CD Player Section

VCD Signal System	AUTO/PAL/NTSC
Signal-to-noise Ratio	60dB
Separation	55dB(1KHz)
Distortion	0.3%
Resolution	1440 X 234 pxels
Brightness	600NITS

### DISC Player Section

DISC Signal System	AUTO/PAL/NTSC
Channels	2
Frequency Response	40Hz to 16KHz
Signal-to-noise Ratio	60dB
Separation	60dB

### Note:

**Due to continuous product improvement, specifications and design are subject to change without notice.**

## Wiring Connection

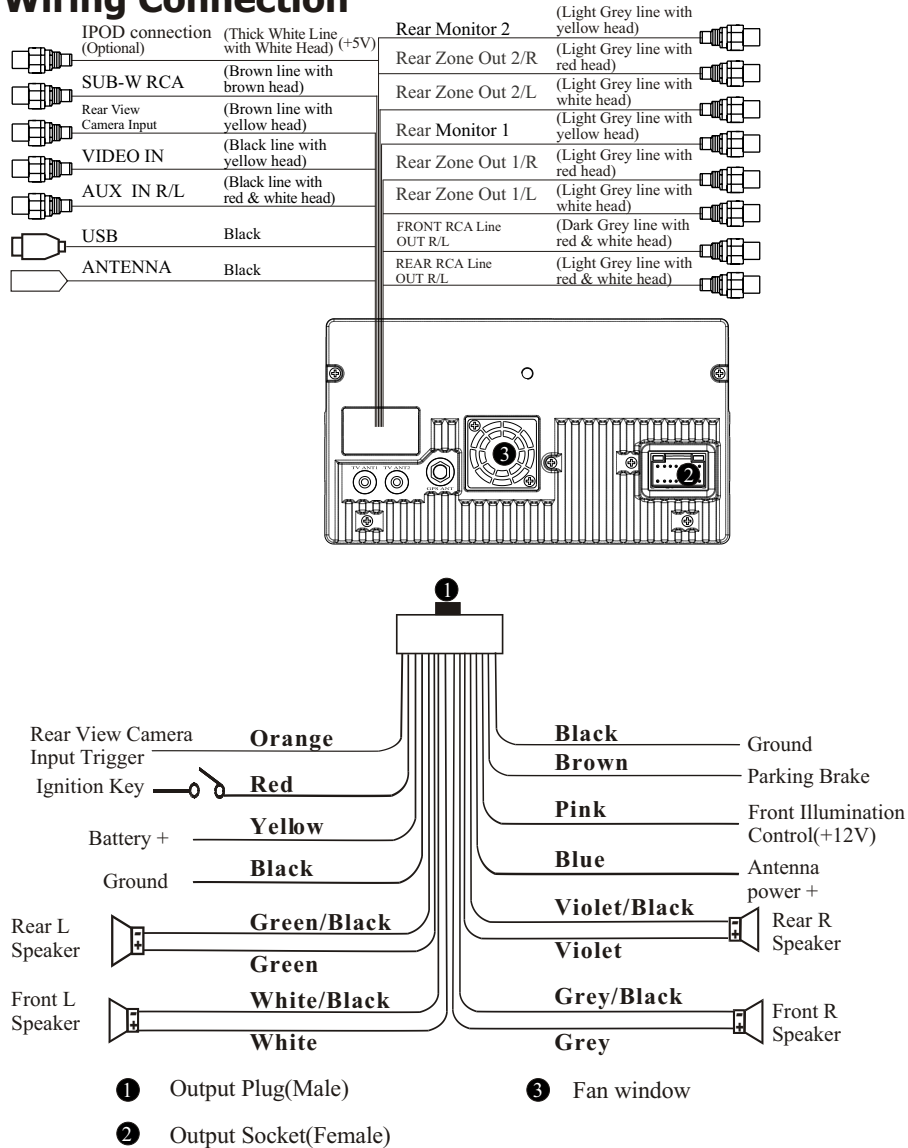

## CD/MP3/SD/USB Setup

During CD playback, touching the screen shows the following menu:

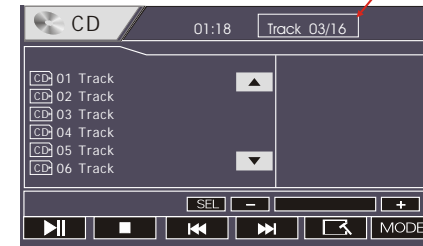

During MP3/SD/USB playback, touching the screen shows the following menu:

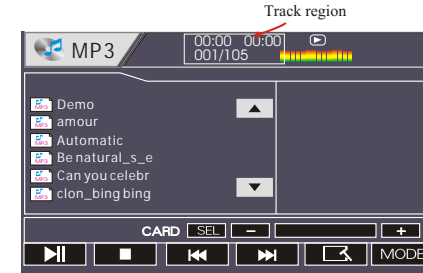

- ▲ ] Scan the tracks
- ▼ ] Scan the tracks
- CARD** CARD appears in the SD mode and USB appears in the USB mode.
- [SEL]** Sound characteristics
- [-]** Decrease volume level, adjust some items
- [+]** Increase volume level, adjust some items
- [▶]** Play/pause
- [■]** Stop
- [◀]** Previous track
- [▶]** Next track
- [⏏]** DISC setup menu
- [MODE]** Mode selector

Track Region: Press this region and the screen shows the following menu: number keys appears, touch the number to select tracks. Touch the "X" to exit this menu.



## CD/MP3/SD/USB Operation

Insert a CD/MP3 disc into the slot, the unit will play automatically.  
Press REL after turning the unit on, then insert a SD card when the TFT is slanted and the programs in the card will be played.  
From the back of the main unit insert the USB and programs in the USB will be played.  
If you have loaded a disc, USB and SD Card, press source to toggle thru and choose which media source you would like to choose.

- Note:**
- \* Press SRC on the main unit to switch to DISC mode. With SD and USB inserted, press this key repeatedly to switch between USB, SD and disc.
  - \* Press **MODE** to turn to mode switch.
  - \* Bit rate not more than 320kbps.
  - \* Supports ID3V1.

---Preferences page--

**Default** Example showing how to set load factory setting:

(Press ▲ or ▼)

--Preference Page--

TV Type	Auto
Audio	Eng
Subtitle	Eng
Disc Menu	Eng
Parental	
Password	
Default	

Go To Preference Page

⇒

(Press ▶, ▲ or ▼, then press ENTER)

--Preference Page--

TV Type	Auto
Audio	Eng
Subtitle	Eng
Disc Menu	Eng
Parental	
Password	
Default	Reset

Load Factory Setting

Installation Method ① : DIN Front-Mount

Bend these claws outward for a tight fit, if necessary.

1 2

3 4

Push in the unit

To support the unit

Fire Wall

Installation Method ②

Installation using the screw holes at the sides of the unit.

Select a position where the screw holes of the mounting bracket supplied with the car and the screw holes of the main unit become aligned (are fitted), and tighten the screws (see at 2 places on each side). And then fasten them to the car.

Bracket supplied to your car

Dashboard or Console

## Detach the Unit

Detach the front panel before disassembling the unit.

1. Take out the Outer Trim Frame.

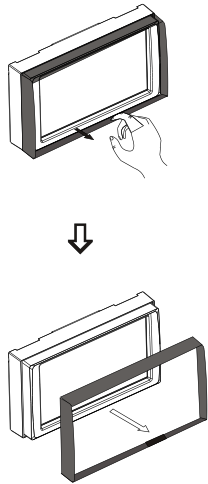

2. Insert the keys supplied to the unit at both sides of the unit (shown as illustrated) until they click. Pulling the keys makes it possible to remove the unit from the dashboard.

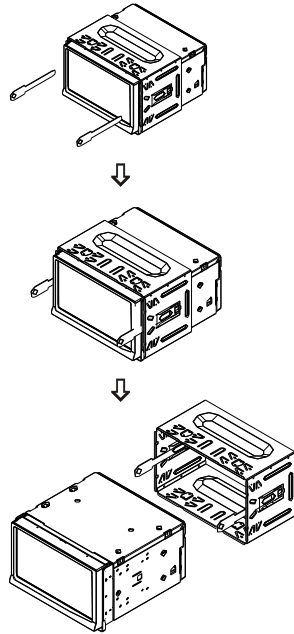

### Main Parts List

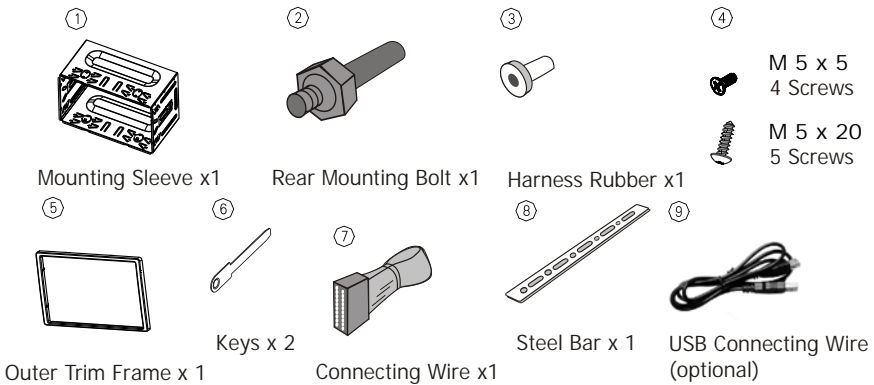

## ---Preferences page---

### Disc Menu

Example showing how to set Disc Menu Language:

(Press ▲ or ▼)

--Preference Page--

TVType	Auto
Audio	Eng
Subtitle	Eng
Disc Menu	Eng
Parental	
Password	
Default	

Go To Preference Page

(Press ►, ▲ or ▼, then press ENTER)

--Preference Page--

TVType	Auto	English
Audio	Eng	French
Subtitle	Eng	Spanish
Disc Menu	Eng	Chinese
Parental		Japanese
Password		Korean
Default		Russian
		Others

Preferred Menu Language

### Parental

Example showing how to set parental control:

(Press ▲ or ▼)

--Preference Page--

TVType	Auto
Audio	Eng
Subtitle	Eng
Disc Menu	Eng
Parental	
Password	
Default	

Go To Preference Page

(Press ►, ▲ or ▼, then press ENTER)

--Preference Page--

TVType	Auto	2 G ▲
Audio	Eng	3 PG
Subtitle	Eng	4 PG 13
Disc Menu	Eng	5 PGR
Parental		6 R
Password		7 NC 17
Default		8 Adult
		Off

Set Parental Control

### Password

Example showing how to set password, and the default password is 8888.

(Press ▲ or ▼)

--Preference Page--

TVType	Auto
Audio	Eng
Subtitle	Eng
Disc Menu	Eng
Parental	
Password	
Default	

Go To Preference Page

(Press ►, ▲ or ▼, then press ENTER)

--Preference Page--

TVType	Auto
Audio	Eng
Subtitle	Eng
Disc Menu	Eng
Parental	
Password	Change
Default	

Change Password

---Preference page---

**Subtitle** Example showing how to set subtitle language:

(Press ▲ or ▼)

--Preference Page--		
TV Type	Auto	
Audio	Eng	
Subtitle	Eng	
Disc Menu	Eng	
Parental		
Password		
Default		

Go To Preference Page

⇒

(Press ►, ▲ or ▼, then press ENTER)

--Preference Page--		
TV Type	Auto	English
Audio	Eng	French
Subtitle	Eng	Spanish
Disc Menu	Eng	Chinese
Parental		Japanese
Password		Korean
Default		Russian
Preferred subtitle Language		Others

**To Select Source by Menu**

In any mode, press SRC in the monitor, the following menu will appear:



Press it to select your desired item: FM, DISC, IPOD, SD Card, USB, AUX, and press SET to enter into the main menu. If you want to enter into Ipod, press IPOD; if it does not enter into, that means the unit does not include the function. In any mode, press SRC to return to the previous mode. Press BACK to return to previous mode.

- Note:**
  - \* If the font display in cyan, that means this does not have this function.

**Reset the Unit**

Operating the unit for the first time or after replacing the car battery, you must reset the unit.

Remove the front panel, then press **RES** button in the panel with a pointed object, (such as a ballpoint pen) to set the unit to initial status.

- Notes:**
  - \* When some errors occur on the display, you can also press **RES** button to resume to normal. It will erase the clock setting and some memorized functions.
  - \* This function can only be operated by the main unit.

**Turning the Unit On/Off**

Briefly press **PWR** button to turn on the unit, during working status, press and hold it to turn off or turn on the unit.

- Note:**
  - \* Pressing PWR button on the main unit also performs the same function.

**Volume Control**

Press **VOL+** button to increase the sound level and press **VOL-** button to decrease the sound level.

- Note:**
  - \* Pressing VOL+/- on the main unit or VOL+/- in the monitor performs the same function.

**Setting the Sound Characteristics**

Repeatedly press **SEL** button to select the desired mode in the following order:



After selecting the desired mode, you can adjust the current level by pressing **VOL** buttons.

- Notes:**
  - \* Pressing VOL+/- and SEL on the main unit also performs the same function.

**EQ Setting**

While listening to the popular music, classic music or rock music, you can select the corresponding preset modes to adjust the sound quality perfectly by using **EQ** button.

Repeatedly pressing **EQ** button to choose the following modes in turn:

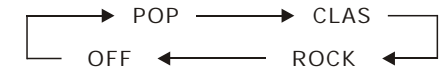

The default setting is OFF.

- Note:**
  - \* This function is operated by using the remote control only.

### Turning Loudness On/Off

Press and hold **LOUD** button to activate the loud function. Pressing the button will increase the low frequency. Press it again to quit this function.

**Note:**

- \* This function is operated by using the remote control only.

### Eject a DISC

Briefly press **▲** while the TFT is slanted to eject a disc or the TFT will return to the initial status.

**Note:**

- \* Pressing **▲** on the remote control also performs the same function.

### Insert a SD Card

Briefly press **REL** after turning the unit on, then insert a common SD card into SD slot when the TFT slanted.

### Angle Setting

Press and hold **REL** till **ANGLE** appears in the monitor, the press **+** to adjust monitor backward by definite angle, press **-** to adjust it forward.

**Notes:**

- \* When adjusting the monitor angle, use this method! Otherwise the unit will be damaged.
- \* This function is operated by the main unit only.

### Mute Function

Press **MUTE** button to shut off the sound output, and “**M**” appears on the LCD. Press it again to resume to previous volume level.

**Note:**

- \* Briefly pressing **MUTE** on the main unit also performs the same function.

### Night Mode

Press and hold **MUTE** button to enter the night mode, press it again to switch to the normal mode.

**Note:**

- \* This function is operated by the main unit only.

### Mode Selector

Repeatedly briefly press **SOURCE** button to select the different modes available.

**Note:**

- \* Briefly Pressing **SRC** on the main unit also performs the same function.

### Infrared Sensor:

Receptor **4** on the main unit for the wireless remote control.

### ---Preference page---

**TV Type** Example showing how to set TV type:

(Press **▲** or **▼**)

--Preference Page--		
TV Type	Auto	
Audio	Eng	
Subtitle	Eng	
Disc Menu	Eng	
Parental		
Password		
Default		

Go To Preference Page

(Press **▶**, **▲** or **▼**, then press **ENTER**)

--Preference Page--		
TV Type	Auto	PAL
Audio	Eng	Auto
Subtitle	Eng	NTSC
Disc Menu	Eng	
Parental		
Password		
Default		

Set TV Standard

**Audio** Example showing how to set Audio language:

(Press **▲** or **▼**)

--Preference Page--		
TV Type	Auto	
Audio	Eng	
Subtitle	Eng	
Disc Menu	Eng	
Parental		
Password		
Default		

Go To Preference Page

(Press **▶**, **▲** or **▼**, then press **ENTER**)

--Preference Page--		
TV Type	Auto	English
Audio	Eng	French
Subtitle	Eng	Spanish
Disc Menu	Eng	Chinese
Parental		Japanese
Password		Korean
Default		Russian
		others

Preferred Audio Language



--General Setup Page--

**Captions** Example showing how to set captions on/off:

(Press ▲ or ▼)

--General Setup Page--		
TV Display	Wide	
Angle Mark	On	
OSD Lang	Eng	
Captions	Off	
Screen Saver	On	

Go To General Setup Page

⇒

(Press ►, ▲ or ▼, then press ENTER)

--General Setup Page--		
TV Display	Wide	
Angle Mark	On	
OSD Lang	Eng	
Captions	Off	On
Screen Saver	On	Off

Closed Captions

**Screen Saver** Example showing how to set Screen Saver on/off:

(Press ▲ or ▼)

--General Setup Page--		
TV Display	Wide	
Angle Mark	On	
OSD Lang	Eng	
Captions	Off	
Screen Saver	On	

Go To General Setup Page

⇒

(Press ►, ▲ or ▼, then press ENTER)

--General Setup Page--		
TV Display	Wide	
Angle Mark	On	
OSD Lang	Eng	
Captions	Off	
Screen Saver	On	On
		Off

Screen Saver

Main Menu Setup

Press and hold SETUP on the remote control or MENU on the main unit, or press SET in the monitor to enter the menu as follows:



This menu includes VIDEO, AUDIO, SOURCE, SYSTEM, EXIT. Press them in the monitor to set the desired status.

**Note:**

\* Press and hold **SETUP** or press **MENU** on the main unit to set up this menu; press them in the monitor to select the option.

1.Video Adjustment

After selecting VIDEO, the sub menu will appear as follows:

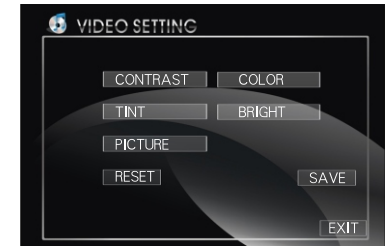

In this menu you can adjust CONTRAST, COLOR, TINT, BRIGHT, PICTURE.

**Picture Adjustment**

Press PICTURE in this menu, it will appear as follows:

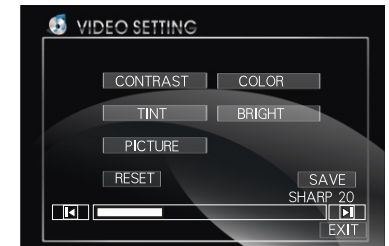

Press and to adjust the size, then press SAVE to save the setup, press EXIT to exit this menu.

**Note:**

\* Adjusting the other options perform the same operation.

## 2. Audio Adjustment

After selecting AUDIO, the sub menu will appear as follows:



You can adjust VOLUME, SUBWOOF, BALANCE, FAD, BASS, TREBLE, For example, press FAD, the setting menu will appear as follow:



Press and to adjust the desired FAD level, press EXIT to exit this menu.

- Note:** \* Adjusting the other options perform the same operation.

## 3. Source Adjustment

In the main menu, press SOURCE in the monitor, the sub menu will appear as follows:



You can switch all of the items to ON or OFF, press the corresponding button to set. If one of them was set OFF, that function is null.

- Note:** \* If the font display is in red, this model does not contain this function.

## 4. System Adjustment

After selecting SYSTEM, the sub menu will appear as follows:

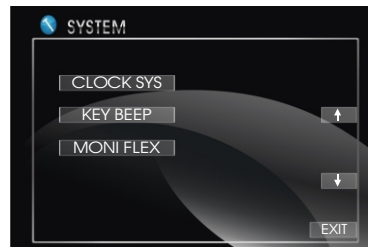

In this menu you can adjust CLOCK SYS, KEY BEEP and so on.

- Note:** \* If the item display in sky-blue, then it can not be set up.

## --General Setup Page--

**TV Display** Example showing how to set TV Display mode:

(Press or )

--General Setup Page--		
TV Display	Wide	
Angle Mark	On	
OSD Lang	Eng	
Captions	Off	
Screen Saver	On	
Go ToGeneral Setup Page		

⇒

(Press , or , then press ENTER)

--General Setup Page--		
TV Display	Wide	Normal/PS
Angle Mark	On	Normal/LB
OSD Lang	Eng	Wide
Captions	Off	
Screen Saver	On	
Set TV Display mode		

**Angle Mark** Example showing how to set picture mode:

(Press or )

--General Setup Page--		
TV Display	Wide	
Angle Mark	On	
OSD Lang	Eng	
Captions	Off	
Screen Saver	On	
Go ToGeneral Setup Page		

⇒

(Press , or , then press ENTER)

--General Setup Page--		
TV Display	Wide	
Angle Mark	On	On
OSD Lang	Eng	Off
Captions	Off	
Screen Saver	On	
Set AngleMark		

**OSD Lang** Example showing how to set language mode:

(Press or )

--General Setup Page--		
TV Display	Wide	
Angle Mark	On	
OSD Lang	Eng	
Captions	Off	
Screen Saver	On	
Go ToGeneral Setup Page		

⇒

(Press , or , then press ENTER)

--General Setup Page--		
TV Display	Wide	English
Angle Mark	On	French
OSD Lang	Eng	German
Captions	Off	Spanish
Screen Saver	On	Italian
Set OSD Language		
		Dutch
		Portuguese

## Selecting MENU

- 1 Selecting Menu: During DISC status, press **4** MENU to return to the root menu, all of the chapters will appear on monitor. You can press **27** or **23** button to select your desired chapter.
- 2 Selecting Title: During DISC status, press **3** TITLE to return the title menu, all of the titles will appear on monitor. You also can press **27** or **23** button to select your desired chapter.

### Note:

- \* Under DISC menu, touch the screen to select items.
- \* If the touch menu options are invalid or the disc does not support touch-TITLE, that is the same as **27** buttons on the remote control will display on the screen. Press **◀** to left, press **▶** to right, press **▲** to up, press **▼** to down and press **●** to ENTER.

## DISC SETUP MENU

Press **19** SETUP on remote control or **13** in the monitor, main menu and sub-menu will appear on the TFT. Press **27** [**▲**][**▼**][**▶**][**◀**] on the remote control to select your desired item, then press ENTER.

Press **▲** to the pervious one, press SETUP or press [**▲**][**▼**][**▶**][**◀**] to move the cursor on "×", then press ENTER to exit the menu setup.

### Notes:

- \* The selections are the preferred options that will be chosen if they are available on a disc. If the disc that is inserted does not have the preferred option then the discs own preference will be used.
- \* Regarding **SETUP MENU**, please refer to the following pages for more details.
- \* Some functions vary depending on the types of models or formats of the disc.
- \* Touch the screen to select menu, touch it again to select the item.

## Clock System

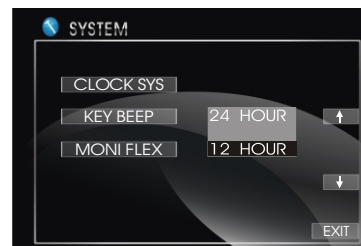

Press CLOCK SYSTEM in the monitor to set 12 HOUR or 24 HOUR in this menu.

## Key Beep

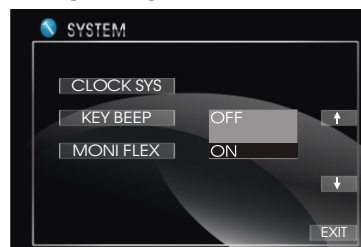

In this menu you can adjust KEY BEEP, press it in the monitor and select ON or OFF, the default setting is ON, it means when you press the keys, they sounded.

## Reverse Pola

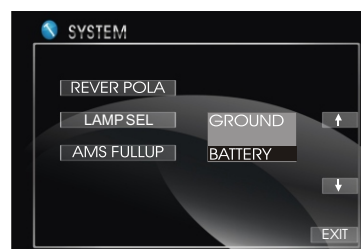

Setting REVERSE POLA in this menu. If the signal is +12V, please press BATTERY in the monitor. If the signal is 0V, please press GROUND.

## Lamp SEL

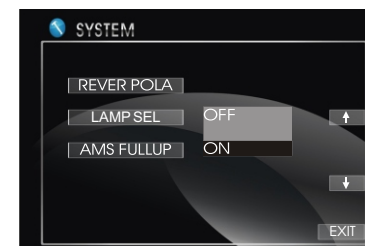

In this menu you can adjust LAMP SEL, press it in the monitor and select ON or OFF, the default setting is ON.

## AMS Fullup

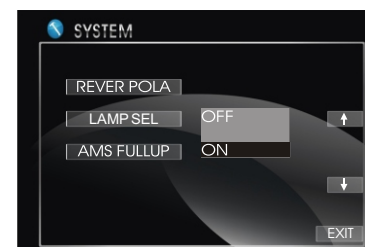

In this menu you can adjust AMS FULLUP. If the setup is ON, when the presettable stations are full, no new station is allowed to store. When you select OFF, it will search continually.

### Local Area

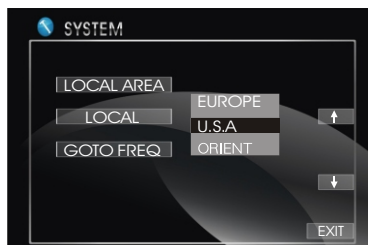

You can select EUROPE or USA or ORIENT to search the stations quickly by your current area.

### Local

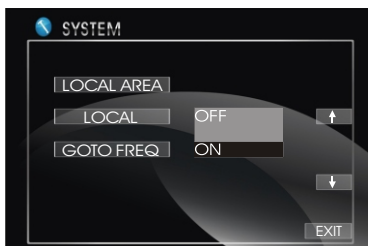

In this menu, you may choose to search Local Stations. When ON is selected, only strong signaled local stations may be received. When this is OFF, weak signal out-of-town stations may be received.

### Goto FREQ

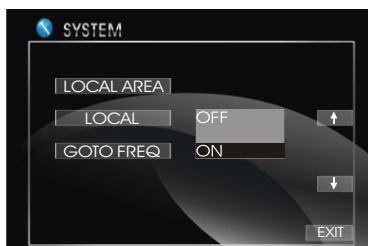

To select ON, you can use the GOTO button on the remote control to select a station's frequency directly by using the numbers.

### RT Scroll

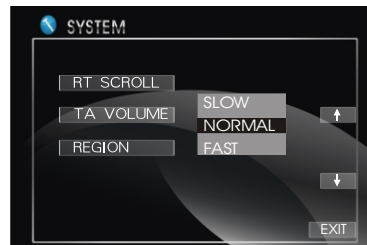

To select your desired speed, SLOW, NORMAL, FAST. The default settings is NORMAL.

### TA Volume

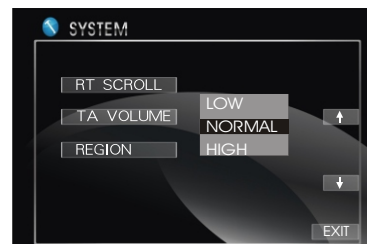

To select your desired volume, LOW, NORMAL, HIGH. The default setting is NORMAL.

### Regional Switch

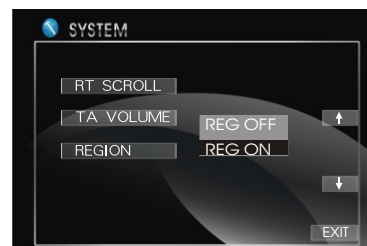

To set the AF searching region, the default setting is ON.

### Changing the viewing angle (Multi-angle)

With DISCs featuring multi-angle (scenes shot from multiple angles) recordings, you can press **7** ANGLE to switch among viewing angles during playback.

Selection options switch as follows:

**ANGLE 1 — ANGLE 2 — ANGLE 3.....**

#### Notes:

- \* This function is operated by using the remote control.
- \* This function only operates with DISCs featuring multi-angle recordings.
- \* The “” mark on a DISC's package indicates it features multi-angle scenes. The number in the “” mark indicates the number of angles from which scenes were shot.
- \* It is invalid to press ANGLE during fast forward/fast reverse or pause.

### Selecting Audio Output

To change audio output, press **6** AUDIO button to select the following channel:

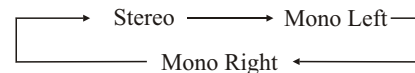

Selecting the corresponding output to set the different sound characters.

#### Note:

- \* This function is operated by using the remote control only.

### Program Playing

During VCD mode, press **13** PROG, the TFT displays the program menu. Press **NUMBER BUTTONS** to select the track Number and then press **27** to move the cursor to **START**, press **ENTER** to start program playing; move the cursor to EXIT and press **ENTER** to exit the program playing. Move the cursor to **◀** and press **ENTER** to the previous page; move the cursor to **▶** and press **ENTER** to the next page. During this process, press **18** **■** to cancel the program playing.

#### Note:

- \* This function is only valid on the remote control.
- \* Press **22** CLEAR to clear the input.

### Playing PBC (Menu)

During VCD status, press **3** TITLE, PCB. Playback starts and the menu of entire disc appears on the monitor. Then you can select your favorite track by using **23** Number Buttons. When a track is playing, you can press **4** MENU to return to the menu if you would like to end the track and select others. To cancel PBC playing, press **3** TITLE button again.

#### Note:

- \* This function is operated by using the remote control.
- \* **PBC** playing confirms to version 2.0 of VCD disc and SVVD disc only.

During VCD status, press **OSD** button the display shows:



During MP4 status, press **OSD** button the display shows:

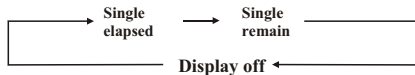

**Note:**

- \* This function is operated by using the remote control.

### Setting the Playback Time

During DISC mode, press **2** GOTO button to set the playing time, when the TFT display : *Title/Chapter/Audio/Subtitle/Angle/TT time/CH time/Repeat/Time Disp.*

Press **27** [▲][▼] to select the options, press ENTER to set the status. Then press **NUMBER BUTTONS** or **27** [▶][◀] to set the current status.

During VCD mode, press **2** GOTO button to set the playing time, when the TFT display : *track/disc time/track time/repeat/time disp.* Press **27** [▲][▼] to select the options, press ENTER to set the status. Then press **23** NUMBER BUTTONS or **27** [▶][◀] to set the current status.

During MP4 playback, first press **2** GOTO, and monitor shows : ---, press your desired track by using number buttons and press **ENTER** to set the status. Second press **GOTO** button, and the monitor shows: -:-:-, input your desired time, then press **ENTER**.

**Note:**

- \* This function is operated by using the remote control.
- \* Press **2** CLEAR to clear the mistake input.

### Changing audio language (Multi-audio)

DISCs can provide audio playback with different language. With DISCs featuring multi-audio recordings, you can press **6** **AUDIO** to switch between language and audio systems during playback.

Selection options switch as follows:

**AUDIO 1 — AUDIO 2 — AUDIO 3.....**

**Note:**

- \* This function is operated by using the remote control.
- \* This function only operates with DISCs featuring multi-audio recordings.
- \* The number in the “**2**” mark on a DISC's package indicates the number of recorded languages/audio systems.

### Changing the subtitle language (Multi-subtitle)

With DISCs featuring multi-subtitle recordings. You can press **5** **SUB-T** to switch between subtitle languages during playback. Selection options switch as follows:

**Subtitles 1 — Subtitles 2 — ..... — Subtitles OFF**

**Note:**

- \* This function is operated by using the remote control.
- \* This function only operates with DISCs featuring multi-subtitle recordings.
- \* The number in the “**2**” mark on a DISC's package indicates the number of recorded subtitle languages.

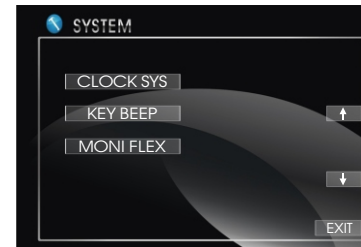

(Picture 1)



(Picture 2)

Press **↑** in picture 1 or press **↓** in picture 2 to enter the following menu:

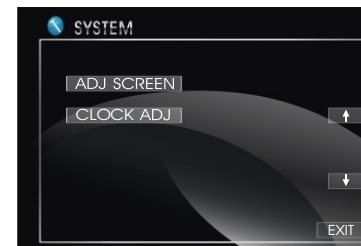

### Adjust Screen



Press **ADJ SCREEN** to display the above menu. Press the square button at the top left **1**, then the button will move to place **2**, press it at place **2**, it will move to place **3**, then place **4**, press **SAVE**.

### Clock Adjustment

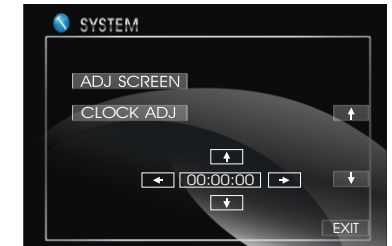

Press **CLOCK ADJ** in the monitor to adjust the clock.

## DISC/VCD/MP4 Setup

During DISC/VCD/MP4 playback, touch the screen. The bottom will display the following menu:



- Play/pause
- Stop
- Decrease volume level
- Increase volume level
- DISC setup menu
- Mode selector

### Note:

- \* Press the right corner repeatedly to play the next track (▶▶ shows), press the left corner to play the previous track (◀◀ shows).

## DISC/VCD/MP4 Operation

Insert a disc into the slot (10), the unit will automatically switch on. If a disc is loaded, press SOURCE on the remote control to start the playback. If the unit is in other menu, press DISC in the monitor to switch to disc play.

### Note:

- \* Press SRC on the main unit to switch to DISC mode. If an SD card and USB is plugged into the unit, press this key over again to toggle between USB, SD and disc.
- \* Pressing [MODE] in the monitor performs the same function.

## Selecting Tracks

During DISC/MP4 playback, press (21) ◀◀ to play previous track, press (21) ▶▶ to play next track.

During VCD playback, press (21) ◀◀ to return to the beginning of the current track, press (21) ◀◀ again within 3 seconds to play previous track, press (21) ▶▶ to play next track.

### Note:

- \* Pressing left/right twice continuously in the monitor also performs the same function.

## Number Buttons

Press one of (23) Number Buttons(0~9) to select a track, it will be played automatically.

### Note:

- \* Press this region and the screen shows the following menu: number keys appears, touch the number to select tracks. Touch the "X" to exit this menu.

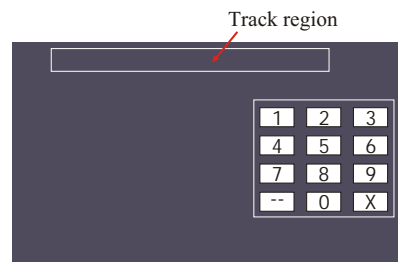

- \* Press (22) CLEAR to clear the input.

## Pause the Playback

During DISC/VCD/MP4 playback, press (17) || to switch between play and pause; During stop mode, press this button to resume playback mode.

### Note:

- \* Pressing [||] in the monitor also performs the same function.

## Stop the playback

During DISC/VCD playback, first press, (18) ■, then press (27) or (17) on the remote control to replay. Press (18) ■ twice to stop playing completely, then press (17) to return to the beginning of the current track. During MP4 playback, press ■ first, then press (17) to return to the beginning of the current track.

### Note:

- \* Pressing [■] in the monitor performs the same function.

## Playing Tracks at Random

During DISC/VCD/MP4 playback, press (16) RDM button on the remote control to play any track at random under the directory which you select. Press it again to return to normal playing.

### Note:

- \* This function is operated by using the remote control.

## Repeat Playing

During DISC playback, press (15) RPT on the remote control to perform replaying function as followings:



During VCD/MP4 playback, press RPT on the remote control to TRACK REPEAT.

### Note:

- \* This function is only valid on remote control.

## Skip backward/forward/F.F /F.REW the playback

Press (20) (◀◀ or ▶▶) on remote control to perform fast rewind or fast forward. Each pressing will change as follow:



### Note:

- \* This function is only valid on remote control.

## System Switch

During DISC/VCD mode, Press (11) P/N on remote control to set the TV standard to PAL or NTSC or AUTO system.

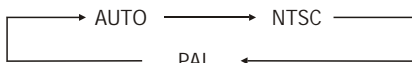

### Note:

- \* The function can be operated by selecting the DISC MENU SETUP.

## Slow motion playback

During DISC mode, press (10) || to slow play. There are speeds as follow:

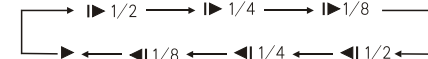

During VCD mode, press (10) || to slow play. There are speeds as follow:



### Note:

- \* The function is only valid on remote control.

## Increase the size of picture

During DISC/VCD/MP4 mode, Press (9) ZOOM to increase the picture in size. There are sizes as follow, Each pressing increases the size until the maximum size is reached.

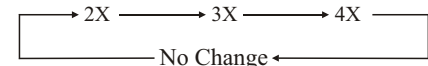

### Note:

- \* The function is only valid on remote control.
- \* To remove the image by pressing (27) button.

## On Screen Display

During DISC status, press (3) OSD button the display shows:

